

# Emotion digital

Efficiency of a multi-shape extensive heating panel  
with energy saving functions

## Characteristics

- ▶ Extensive heat panel with sensors, black painted extruded aluminum heating element & digital display
- ▶ Up to 45% energy savings\* thanks to integrated programming and Sweetcontrol presence detector
- ▶ Standard and high versions to adapt to the customer's rooms specifications

## Comfort

- Extruded aluminium heating element with large surface diffuser
- Temperature setting displayed on digital unit

## Savings

- Window open/closed detection function switching to minimum heating function as soon as a window opens (standard and high)
- Presence /absence detection functions
- Consumption indicator for responsible, informed use of the equipment
- 6-command pilot wire: Comfort, Comfort- 1°C, Comfort - 2°C, Eco, Frost-free, Off
- Electronic thermostat

## User-friendliness

- Built-in programming (3 pre-set programmes per day)
- ASP (Anti-Staining Process) to reduce staining on wall and on equipment
- Easy to install: H-shaped vertical support, which can also be used as an installation template

## Design





- Two models: standard and high
- Colour shade: white (RAL 9016)
- Heating light indicator



Standard

High

## Easy to install

<b>Models available**</b>  1   2   3   4	<b>Output</b> EXTENSIVE HEAT PANEL HEATER <b>500 TO 2000 W</b>	<b>Energy savings</b> 
<b>Controls</b>  Digital controls	<b>Technology</b>  Presence sensors	<b>Heating element type</b>  ALUMINIUM HEATING ELEMENT

Water Heating  
Heating  
Ventilation  
Heat Pumps



- 1 Digital controls
- 2 Over-heating safety device
- 3 Perforated frontal air outlet
- 4 Extruded aluminium heating element
- 5 Room temperature sensor
- 6 Movement and light sensors

#### DIGITAL CONTROL PANEL



- 1 Mode switch
- 2 Menu button to access appliance various functions
- 3 Heating light indicator
- 4 OPEN WINDOW function Switch to anti-frost protection mode during air
- 5 Presence /absence detection functions

time. After the function is deactivated manually, return to the current heating mode

Presence & absence detection functions combined with Window open/closed detection



UP TO  
**45%**  
ENERGY  
SAVINGS\*

#### Installation dimensions (in mm)

Standard

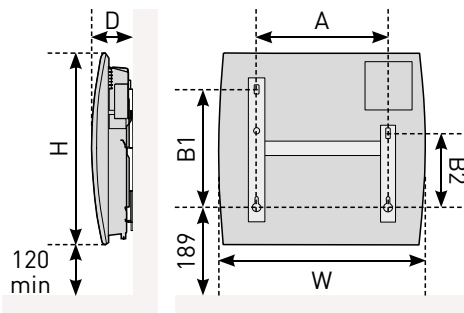

High

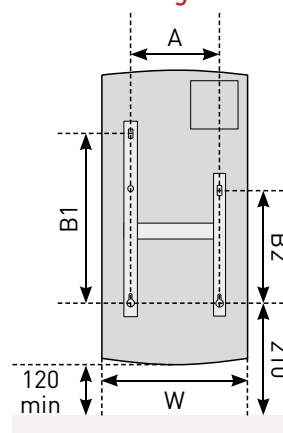

#### EMOTION DIGITAL

##### Technical data

Output (W)	Dimensions (mm)						Net weight (kg)
	Width (W)	Height (H)	Depth (D)	A	B1	B2	
<b>Emotion Digital Standard</b>							
500	465	470	120	195	251	158	4.3
750	540	470	120	269	251	158	4.9
1000	615	470	120	343	251	158	5.5
1250	765	470	120	491	251	158	6.2
1500	840	470	120	565	251	158	7.1
2000	1060	470	120	789	251	158	10
<b>Emotion Digital High</b>							
1000	470	775	135	532	444	158	7.2
1500	470	995	135	828	740	158	9.3
2000	470	1220	135	976	888	158	11.3

